

DSH600 Cut-off Saw

Petrol driven, heavy duty, hand held saw for on-site cutting of masonry, bricks. Concrete and metalwork.



Code **07123**

Be alert to movement of the work piece or anything else that can occur, which could cause the cut to close and pinch the blade.

Fitting the cutting blade

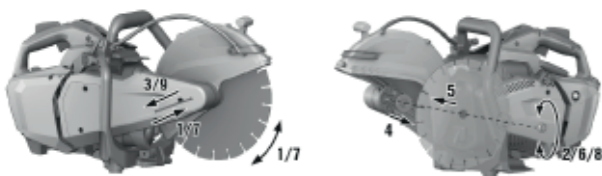

1. Insert the locking pin in the hole in the drive belt cover and turn the cut-off wheel until the locking pin engages.
2. Release the securing screw by turning the screw counter-clockwise with the wrench and then remove the screw and washer.
3. Remove the locking pin.
4. Remove the clamping flange and the cut-off wheel.
5. Check that the diameter of the arbor hole in the cut-off wheel to be fitted matches the centering collar of the cut-off wheel mounting flange. **The mounting flange has a 20mm diameter centering collar on one side and a 25.4mm (1") diameter centering collar on the other side.**
6. Clean the clamping and centering surfaces on the tool and on the cut-off wheel.
7. Select one of the following alternatives.

Alternative 1/2



Use only the large flange to secure the abrasive cut-off wheel.

Alternative 2/2



Use the small flange with diamond cut-off wheels in order to utilize the full cutting depth.

8. Place the cut-off wheel with centering collar on the drive arbor and check that the direction of rotation is correct. **The direction-of-rotation arrow on the cut-off wheel must match the direction indicated on the tool.**
9. Place the clamping flange and washer on the drive arbor and tighten the securing screw by turning it clockwise.
10. Insert the locking pin in the locking hole in the drive belt cover and turn the cut-off wheel until the locking pin engages.
11. Securely tighten the clamping screw (tightening torque: 25Nm).
12. Remove the locking pin.

WARNING!

Risk of injury. Contact with the cut-off wheel and flying fragments or sparks can cause injury to persons. Adjust the guard so that flying particles or fragments of the material removed and flying sparks are directed away from the operator and the product.

13. After fitting a new cut-off wheel, run the tool at full speed under no load for approximately 1 minute.

Guard for the blade

The guard must always be fitted on the saw. The guard for the cutting equipment should be adjusted so that the rear section is flush with the work piece. Spatter and sparks from the material being cut are then collected.

When cutting hold the machine's handle so that the hands are in line with the cutting blade. This is to achieve maximum cutting speed, disc service life and a straight cut.

Technical specifications

Weight	9.85kg
Vibration FH	2.5m/s ²
Vibration RH	2.5m/s ²
Sound Level	102dB(A)
Gt Level	115
Cutting Depth	120mm

Equipment care

Never push the equipment beyond its design limits. If it will not do what you want with reasonable ease and speed, assume you have the wrong tool for the job. Contact HSS Hire for advice.

Keep the equipment clean - you will find this less of a chore if you clean it regularly, rather than wait until the end of the hire period.

When not in use, **store the equipment somewhere clean, dry and safe.**

Cutting blades should be stored in dry, frost free conditions.

Special care should be taken of abrasive discs. Store them on a flat, level surface. If an abrasive disc is stored in humid conditions, this can cause imbalance and result in injury.

Finishing off

Select machine stop, wait for the engine to stop and the cutting wheel to stop rotating. If the saw is not to be used again, **remove the cutting blade. Give the machine a final clean and attach the spanner to the machine ready for return to HSS Hire.**

Fitting the water pump

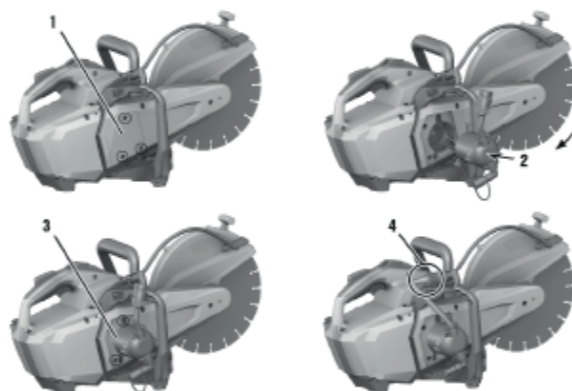

1. Switch the product off
2. Release the three pump cover retaining screws, remove the parts and store the pump cover in a safe place. The pump cover must be fitted if the tool is used without the water pump.
3. Hold the water pump in position and turn the cut-off wheel slightly to bring the splines of water pump and clutch bell into alignment so that the splines engage. The position is keyed so it is not possible to position the pump incorrectly.
4. Install the three securing screws and tighten them. Tightening torque: 8Nm
5. Connect the pump hose to the hose connector of the saw.
6. Remove the protective cap from the end of the water connection hose.

7. Make sure that the water pressure in the water supply line is max, 6 bar. Reduce the water pressure as necessary.
8. Connect the water pump to the water supply or immerse the end of the suction hose in a container filled with water.

Fit the protective cap to the end of the water connection hose when the water pump is not connected to a water supply.

**Any problems?
We are here to help.**



**Contact us on
03457 28 28 28**

Have you been trained?

The law requires that personnel using this type of equipment in the workplace must be competent and qualified to do so. Training is available through HSS Training 03457 66 77 99.

Any comments?

If you have any suggestions to enable us to improve the information within this guide, please email your comments or write to the Safety Guide Manager at the address below: safety@hss.com

©HSS ProService Ltd. 2024 No. 3013/01

Building Two, Think Park, Mosley Road, Trafford Park,
M17 1FQ

www.hss.com

General safety

For advice on the safety and suitability of this equipment contact HSS Hire.

There is a serious risk of personal injury if you do not follow all instructions laid down in this guide.

The hirer has a responsibility to ensure that all necessary risk assessments have been completed prior to the use of this equipment.

This equipment should only be used by an operator who has been deemed competent to do so by their employer.

This equipment should be used by a competent adult who has read and understood these instructions. Anyone with either a temporary or permanent disability should seek expert advice before using it.

Keep children, animals and bystanders away from the work area. Cordon off a NO GO area using cones and either barriers or tape available for hire from HSS Hire.

Never use this equipment if you are ill, feeling tired, or under the influence of alcohol or drugs.

Safety goggles MUST be worn by everyone in the work area.

This equipment generates potentially harmful noise levels. To comply with health and safety at work regulations ear defenders must be worn by everyone in the vicinity.

Some materials when cut contain substances which, when inhaled, can be harmful to health. A suitable mask must be worn when using this equipment. Respiratory protective equipment is available for hire, contact HSS Hire for details.

Wear practical, protective clothing, gloves, footwear and a protective hard hat. Avoid loose garments and jewellery that could catch in moving parts, tie back long hair.

Ensure the work area is well lit and ventilated, if in doubt, ask about lighting and ventilation equipment at HSS Hire.

Do not work near flammable gases or liquids: petrol or paint thinner fumes for example. Keep combustible materials at a safe distance - at least 5m.

Make sure you know how to switch this machine OFF before you switch it ON in case you get into difficulty.

Never leave the unit running and unattended. Always switch the engine off and wait for moving parts to come to rest before making adjustments to it. Engines, especially the exhausts, get very hot so switch OFF and allow to cool before touching them.

EXHAUST DANGER

NEVER operate petrol engines indoors or in a confined space. The exhaust contains gasses that can kill. Always ensure there is adequate ventilation when handling fuel.

FUEL SAFETY

NEVER refuel while the engine is hot or running. NEVER smoke or allow naked lights into the area while refuelling. NEVER inhale fuel vapour. ALWAYS mop up spillage's as quickly as possible, and change your clothes if you get fuel on yourself. ALWAYS store fuel in purpose-made sealed containers, in a cool, safe place well away from the work area.

NEVER start the machine if you have spilt fuel on it, or if the machine is leaking fuel.

Make sure that everyone is warned of what you are doing.

Check the condition of the equipment before use. If it shows signs of damage or excessive wear, return it to HSS Hire.

Ensure the guard is correctly fitted and secure before starting work.

Never use a cutting blade for any other materials than that it was intended for.

Never use a cutting blade at a lower speed rating than that of the power cutter.

Check the cutting blade does not show signs of damage. A damaged cutting blade can cause personal injury.

Always ensure you have a safe and stable working position.

Do not use the machine in bad weather, such as dense fog, rain, strong wind, intense cold etc. Working in bad weather is tiring and can lead to dangerous conditions.

Observe the increased risk of kickback when cutting soft materials.

Do not use the machine unless you are able to call for help in the event of an accident.

Never use a machine that is faulty.

COSHH information sheets available from HSS Hire.

WARNING!

Under no circumstances should you modify the original design of the machine. Unauthorised modifications and/or accessories may lead to serious injury or death to the user or others.

Getting started

A Cut Off Saw is a dangerous tool if used carelessly or incorrectly and can cause serious, even fatal injuries. It is extremely important that you read and understand the contents of this user guide.

Identifier

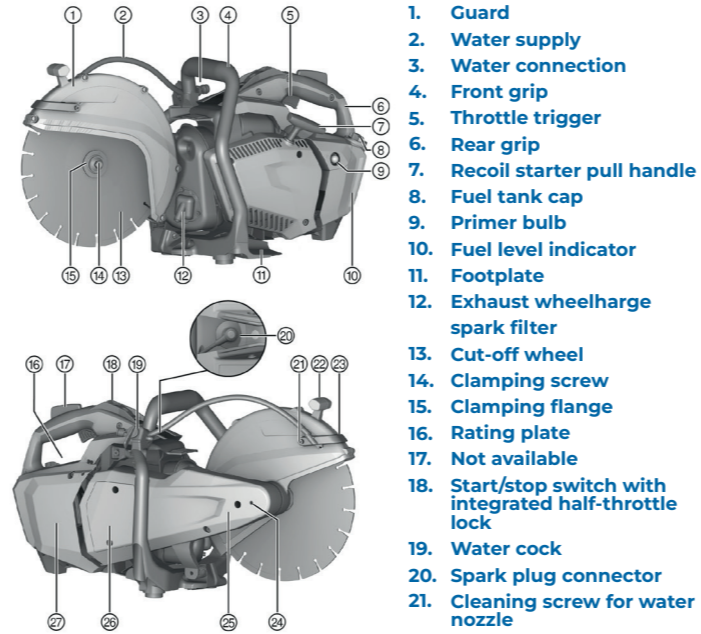

The saw is equipped with a vibration damping system designed to minimise vibration and make operation easier. Stop the machine if you experience discomfort or numbness during use.

FUEL (UNLEADED 2 STROKE 50:1 MIX)

The saw is equipped with a two-stroke engine and must always be run using a mixture of petrol and two-stroke oil. It is important to accurately measure the amount of oil to be mixed to ensure the correct mixture is obtained. Always mix the petrol and oil in a clean container intended for fuel.

Only use semi or fully synthetic two-stroke oil.

Mix (shake) the fuel mixture thoroughly before filling the machine's fuel tank.

If the machine is not used for some time the fuel tank should be emptied and cleaned.

Starting the engine

DANGER! - Risk of asphyxiation. Carbon monoxide, unburned hydrocarbons and benzene in the exhaust gas may cause asphyxiation.

Don't work in closed rooms, trenches or pits and make sure the area is well ventilated.

WARNING! - Risk of burning injury. The exhaust system gets extremely hot when the engine is running. It stays hot for a long time after the engine is switched off.

Wear protective gloves and avoid touching the exhaust system.

Do not lay the product down on flammable material while hot.

WARNING! - Risk of injury. A damaged exhaust system raises the noise level above the permissible limit and increases the risk of suffering hearing damage.

Never use the product if the exhaust system is damaged, missing or if it has been tampered with.

WARNING! - Risk of injury if product is operated without the cover for the water pump correctly installed. Touching the water pump connection during operation leads to injuries.

WARNING! - Risk of injury due to substances and gasses igniting. Burns and fatalities can result.

Do not use the product if flammable substances and gasses are present.

Ensure adequate ventilation.

CAUTION! - Risk of burns or injury through pinching fingers when the water pump is fitted. Touching the pump housing can cause burning injuries.

Hold the forward grip only at the top and on the left side.

Checks after starting the engine

1. Check that the cut-off wheel remains stationary when the engine is idling and after briefly running at full-throttle speed, that the wheel again comes to a complete standstill. If the cut-off wheel rotates when the engine is idling, reduce the idling speed. If this is not possible, return the product to HSS Hire.
2. Check the run/stop switch is functioning correctly. Move the run/stop switch to the STOP position.

Switching the engine off

WARNING! - Risk of injury. A rotating cut-off wheel can break or shatter, possibly resulting in flying fragments.

Allow the rotating cut-off wheel to come to a complete standstill before you lay the saw down.

1. Release the throttle trigger
2. Move the start/stop switch to the STOP position. The engine stops

Cutting blades

Cutting blades are available in two basic designs; abrasive discs and diamond blades. Before using the saw **check that the cutting blade is fitted correctly and does not show signs of damage.**

Always remove the cutting blade when the machine is transported.

Ensure that the blades conform to all regulations and demands that concern this type of saw. For more information contact HSS Hire.

Basic techniques

This information is never a substitute for professional skills and experience.

If you get into a situation where you feel unsafe, stop and seek expert advice.

Do not attempt any task that you feel unsure of!

WARNING!

Under all circumstances avoid grinding using the side of the blade; it will almost certainly be damaged, break and can cause immense damage. Only use the cutting section.

Do not pull the power cutter to one side, this can cause the blade to jam or break resulting in injury.

Kickback

The word **kickback** is used to describe the sudden reaction that causes the saw and cutting blade to be thrown from an object when the upper quadrant of the blade, known as the kickback zone, touches an object.

Kickback can happen very suddenly and violently, kicking the saw and cutting blade back at the user. If this happens when the cutting blade is moving it can cause very serious, even fatal injuries. It is vital you understand what causes kickback and that you can avoid it by taking care and using the right working technique.

Never start to cut with the upper quadrant of the blade as shown in the figure, also known as the kickback zone.

Always hold the machine in a firm grip with both hands. Hold it so that the thumbs and fingers grip around the handles.

Keep a good balance and a firm foothold. **Always cut at maximum speed.** Stand at a comfortable distance from the work piece.

Take care when inserting the blade in an existing cut. Never cut above shoulder height.

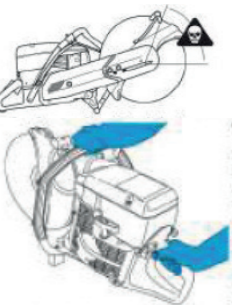

HSS Hire

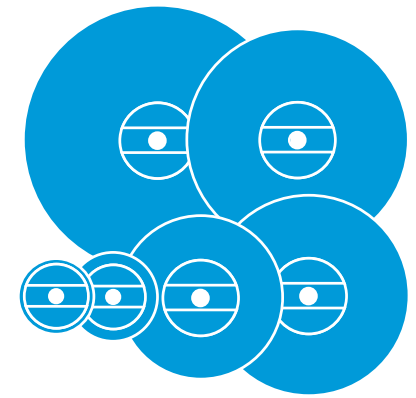

Abrasive Discs

Reinforced, flat Cut Off discs.
Reinforced depressed centre
Grinding Discs



Note that some machines have reversible front flanges to take thick and thin abrasive discs. Make sure such flanges are the right way round for the chosen disc.

Use the right disc mounting flanges, ensuring they are clean, undamaged and free from burrs.

Ensure the flange size is compatible with the size of the disc. Above 230mm, the flange diameter must be one third that of the disc.

To fit a disc, follow the instructions supplied with your machine.

If you have hired the machine from HSS, contact HSS Hire if you have any problems.

In any case, never force a disc onto the machine's spindle and never over-tighten the machine's mounting bolt / flange.

Before switching the machine back ON, remember to reposition the safety guard.

Finally, run newly fitted discs at operating speed for at least one minute before using them to cut / grind. This helps 'seat' the disc and lets you double-check that you have fitted it correctly. Clear the work area while doing this.

Throw used discs away, NEVER re-use a disc once it has been removed from a machine.

USING DISCS

Make sure the workpiece is firmly and safely secured.

If using a portable machine, adopt a comfortable, balanced stance that lets you support and control the machine, keeps the whole of your body clear of the disc, and lets you see clearly what you are doing.

Ensure the work area is free from trip hazards and that the ground offers a secure footing.

If using a grinding disc with a depressed centre, always hold it at an angle to the workpiece.

When cutting, work in a straight line, taking care not to trap or pinch the disc in the cut.

Never try to force the disc through the workpiece and never apply pressure to the side of the disc.

Never use a grinding disc for cut-off work or vice versa. If in doubt, contact HSS Hire.

Regularly check the disc's condition and replace if worn or damaged.

Ensure replacement discs are distortion free and undamaged and that the paper washers are not wrinkled or torn. NEVER FIT SUBSTANDARD OR OLD, USED DISCS.

Don't grind on the side of cut-off or grinding discs less than 4.5mm thick. They are not strong enough. Use the edge instead.

FINISHING OFF

When you have finished using a portable machine, wait for the disc to stop turning and put the machine down gently - taking care not to knock the disc. Ideally, rest the machine, clear of the ground, on a suitable cradle.

Always let the disc come to a halt naturally.

Grinding Operation

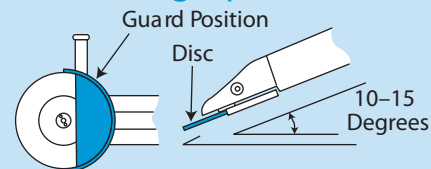

Cutting Operation

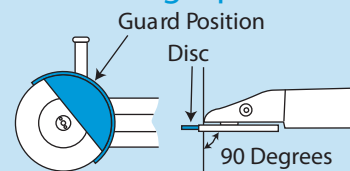

... have you been trained

The law requires that personnel using this type of equipment in the workplace must be competent and qualified to do so. Training is available at HSS Training 0845 766 7799

...any comments?

If you have any suggestions to enable us to improve the information within this guide please e-mail your comments or write to the Safety Guide Manager at the address below e-mail: safety@hss.com

©HSS Hire Service Group Ltd 2020 No. 631/02

76 Talbot Road, Old Trafford, Manchester, M16 0PQ

www.hss.com

GENERAL SAFETY

For advice on the safety and suitability of this equipment contact HSS Hire.

There is a serious risk of personal injury if you do not follow all instructions laid down in this guide.

The hirer has a responsibility to ensure that all necessary risk assessments have been completed prior to the use of this equipment.

This equipment should be used by an able bodied, competent adult who has read and understood these instructions. Anyone with either a temporary or permanent disability, should seek expert advice before using it.

Keep children, animals and bystanders away from the work area.

 Never use this equipment if you are ill, feeling tired, or under the influence of alcohol or drugs.

 Safety Goggles MUST be worn by everyone in the work area.

 Some materials when cut contain substances which, when inhaled, can be harmful to health. A suitable mask must be worn when using this equipment.

 Grinding and cutting equipment generates potentially harmful noise levels. To comply with health and safety at work regulations, ear defenders must be worn by everyone in the vicinity.

 Wear gloves, protective clothing and footwear that covers all exposed skin. Avoid loose garments and jewellery that could catch in moving parts, tie back long hair.

If you sustain an injury while using an abrasive disc, seek medical advice immediately.

Ensure the work area is well lit and ventilated, if in doubt, ask about dust extraction and ventilation equipment at HSS Hire.

Do not work near flammable gasses or liquids, petrol or paint thinner fumes for example. Keep combustible materials at a safe distance - at least 5m.

If working above ground-level, work from a suitable, stable platform - an access tower for example. Never work from ladders or steps.

Take special care when cutting into anything containing pipework or electrical cables. If in doubt, hire a cable avoiding tool from HSS Hire, to determine the exact position of such hazards.

Stop the machine if you experience discomfort or numbness during use.

Make sure you know how to switch the machine OFF before you switch it ON in case you get into difficulty.

Always switch OFF and unplug any tool before making adjustments to it.

Check that it is switched OFF and that you have removed all spanners and keys before plugging it back in.

Having switched OFF, always wait for the disc to come to rest before putting the tool down.

Check the condition of the equipment before use.

Ensure side handles and guards are correctly adjusted and secure before starting work.

Watch your footing. Take special care if working other than on firm, level ground.

Information on COSHH regulations is available HSS Hire.

Warning

Abrasive discs operate at very high speeds. If they should break in use, the fragments that fly off can be extremely dangerous. So, always treat them with respect and follow the safety rules.

ELECTRICAL SAFETY

 To reduce the risk of electric shock, use a suitable RCD (Residual Current Device) available from HSS Hire, or power the equipment from a mains circuit with a built-in RCD.

MACHINE SAFETY

Make sure you know how to operate your particular grinding or cut-off machine safety and correctly.

If using an HSS MACHINE...

Read the Operating & Safety Guide supplied with it. If you have any queries, contact HSS Hire for advice.

If using your OWN MACHINE have it professionally serviced regularly and tested for electrical safety. In particular, check the tension of any drive belts, and double check that any built-in speed control governor is working correctly.

Have its spindle speed checked regularly. Always have the speed checked if the machine has just been serviced or repaired.

WHATEVER you are using...

Make sure the machine is fitted with an adequate, securely fitted safety guard.

Make sure the safety guard is correctly positioned before switching the machine ON. It should cover at least half the disc and protect the user if the disc should accidentally break up in use.

Check the machine's general condition before use, paying special attention to the state of the disc flange plates. If it shows signs of damage or excessive wear, do not use it! If you have any doubts about the condition of an HSS machine, return it to HSS Hire.

DISC SAFETY

Use the correct disc for your grinding / cut-off machine. In particular, check that the machine's spindle speed does not exceed the maximum at which the disc can safely run.

Use the right abrasive disc for the job. If in doubt, contact HSS Hire for advice.

Handle abrasive discs with care. They are easily cracked if knocked or dropped - cracked discs are potentially dangerous.

Always check the discs for damage before use. Brush off any dust and tap gently with a non metallic object. If the disc sounds 'dull' assume it is cracked.

Never fit or use a disc you think may be damaged.

DISC STORAGE

Stack flat cut-off discs one on top of the other, ideally on a flat, level, steel base-plate. Discs with a depressed centre should either be carefully stacked one on top of the other or, better still, left in their original protective packaging.

Never store abrasive discs where they will be exposed to extreme temperatures or damp. Improper storage damages the discs. Always check expiry date.

RULES AND REGULATIONS

Note that the use of abrasives discs in certain conditions (in the work place) are regulated by law. Both the discs themselves, and the way in which they are fitted and used, must conform to BS4481 and BS4581. If in doubt, contact HSS Hire for advice.

DISC FITTING

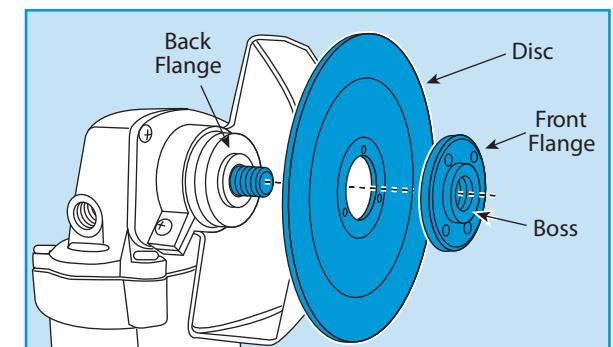

Abrasive discs should only be fitted by authorised, trained personnel.

Before fitting a disc, switch OFF the grinding / cut-off machine and unplug it if electric.

Use the proper tools to change / fit discs. These are supplied with machines hired from HSS. If using your own machine, consult the manufacturer's instructions.

Know Your Symbols

HSS have created clear Icons to inform the hirer of their responsibilities towards the safe use of hire equipment.

These are designed to reduce the amount of different safety information labels required for each product for hire.

General use PPE / Warning

Clearly marked minimum PPE will be visible on all equipment,



Correct PPE must be worn



HAV Hand Arm Vibration



Danger Rotating blade



Danger Hot exhaust

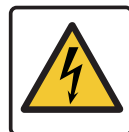

Danger Electric shock



Caution Abrasive Wheel



Caution Finger trap

Fuel and Supply Types



Pe
Petrol



Di
Diesel



2t
2 - Stroke Petrol



EI
Electric

Safe Procedures

All hirers must understand and respect the safe procedures of all equipment.

It is the responsibility of the hirer to maintain and return the equipment in a clean condition and good working order.



Ro
Read OPS Guide



Ou
Outdoor Use only



HI
Heavy Lifting



Cd
Check Oil daily



Cf
Check Fuel daily



Cw
Check Water daily



Bc
Battery Care



Sh
Safe Height Working



Swl
Refer to Data Plate



V
Check Power Voltage Data Plate

Electrical Safety

Safe wiring procedures.



Ea
Must be Earthed Class 1

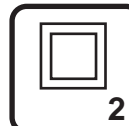

Doi
Double Insulated Class 2



Enl
Earth Live Neutral Wire Coding

Return Responsibility

Charges apply to equipment returned dirty and damaged.



Cc
Cleaning Charge



Rc
Repair Charge